

# FX9500 RFID Reader USER GUIDE





## ***FX9500 User Guide***

*72E-150900-03*

*Revision A*

*January 2012*

© 2011-2012 Motorola Solutions, Inc. All rights reserved.

No part of this publication may be reproduced or used in any form, or by any electrical or mechanical means, without permission in writing from Motorola. This includes electronic or mechanical means, such as photocopying, recording, or information storage and retrieval systems. The material in this manual is subject to change without notice.

The software is provided strictly on an “as is” basis. All software, including firmware, furnished to the user is on a licensed basis. Motorola grants to the user a non-transferable and non-exclusive license to use each software or firmware program delivered hereunder (licensed program). Except as noted below, such license may not be assigned, sublicensed, or otherwise transferred by the user without prior written consent of Motorola. No right to copy a licensed program in whole or in part is granted, except as permitted under copyright law. The user shall not modify, merge, or incorporate any form or portion of a licensed program with other program material, create a derivative work from a licensed program, or use a licensed program in a network without written permission from Motorola. The user agrees to maintain Motorola’s copyright notice on the licensed programs delivered hereunder, and to include the same on any authorized copies it makes, in whole or in part. The user agrees not to decompile, disassemble, decode, or reverse engineer any licensed program delivered to the user or any portion thereof.

Motorola reserves the right to make changes to any software or product to improve reliability, function, or design.

Motorola does not assume any product liability arising out of, or in connection with, the application or use of any product, circuit, or application described herein.

No license is granted, either expressly or by implication, estoppel, or otherwise under any Motorola, Inc., intellectual property rights. An implied license only exists for equipment, circuits, and subsystems contained in Motorola products.

MOTOROLA, MOTO, MOTOROLA SOLUTIONS and the Stylized M Logo are trademarks or registered trademarks of Motorola Trademark Holdings, LLC and are used under license. All other trademarks are the property of their respective owners.

Motorola Solutions, Inc.  
One Motorola Plaza  
Holtsville, New York 11742-1300  
<http://www.motorolasolutions.com>

---

## Warranty

For the complete Motorola hardware product warranty statement, go to:  
<http://www.motorola.com/enterprisemobility/warranty>.

---

## Revision History

Changes to the original manual are listed below:

Change	Date	Description
-01 Rev A	7/2011	Initial release
-02 Rev A	10/2011	Add instructions to change password.
-03 Rev A	1/2012	Update Set Regulatory Mode.



# Table of Contents

Warranty .....	ii
Revision History .....	iii

## Table of Contents

### About This Guide

Introduction .....	ix
Configurations.....	ix
Chapter Descriptions .....	x
Notational Conventions.....	xi
Related Documents and Software .....	xi
Service Information.....	xii

### Chapter 1: Getting Started

Introduction .....	1-1
RFID Reader Hardware .....	1-2
Reader Software .....	1-4
Embedded RFID Reader Web Console .....	1-4

### Chapter 2: RFID Reader Installation

Introduction .....	2-1
Mechanical Installation .....	2-2
Mounting the RFID Reader .....	2-2
Mounting the Antennas .....	2-3
Electrical Installation .....	2-4
Connecting the Serial Port .....	2-5
Connecting the USB Ports .....	2-5
Connecting and Configuring the Ethernet Port .....	2-5

Connecting the Antennas .....	2-6
Connecting Digital Inputs/Outputs .....	2-7
Connecting the Power .....	2-7

### Chapter 3: RFID Reader Operation

Introduction .....	3-1
RFID Reader Operation with Web Console .....	3-1
Change Password .....	3-3

### Chapter 4: Embedded Web Console

Introduction .....	4-1
Embedded Web Console .....	4-2
Basic Configuration .....	4-3
Configuration Page Header .....	4-3
Manage Profiles .....	4-4
Set Tag Protocol .....	4-5
Setup Ethernet/LAN .....	4-7
Setup Serial Port .....	4-9
Setup Digital Accessories .....	4-10
Setup Antenna/Cables .....	4-11
Set Regulatory Mode (Region) .....	4-12
Setup Summary .....	4-13
Advanced Functions .....	4-14
Firmware Management .....	4-14
Import/Export Configuration .....	4-15
Command Line .....	4-16
Expert Configuration .....	4-17
Expert Configuration - Version .....	4-19
Expert Configuration - Information .....	4-20
Expert Configuration - Communication .....	4-21
Expert Configuration - Antennas .....	4-22
Expert Configuration - Digital I/O .....	4-23
Expert Configuration - Modem .....	4-24
User Application Management .....	4-25
Change Operating Mode .....	4-26
View Tags .....	4-27
Check Reader Status .....	4-28
Review Logs .....	4-29

### Chapter 5: Configuring Digital Inputs and Outputs

Introduction .....	5-1
Digital Inputs .....	5-1
Digital Outputs .....	5-1
Digital I/O Monitoring and Control Scripts .....	5-1
scan_trigger.py .....	5-2
scan_trigger_timer.py .....	5-2
signal_read.py .....	5-3



signal_read_crc_error.py .....	5-3
rf_mon.py .....	5-4
Digital Input Alarm Generation .....	5-4
Digital I/O Hardware Connection .....	5-5

## Appendix A: Technical Specifications

Introduction .....	A-1
Reader Specifications .....	A-2
Environmental Specifications .....	A-3
Power Supply Specifications .....	A-3
RS-232 Specifications .....	A-4
Digital Input/Output Specifications .....	A-4
Ethernet LAN Specifications .....	A-5
FX9500 Antenna Specifications .....	A-6

## Appendix B: Safety Instructions

Power Disconnect Device .....	B-1
RF Safety .....	B-1
Electrostatic Discharge .....	B-1
Regulatory Compliance .....	B-2
.....	B-2

## Appendix C: Disposal of Reader

## Index



# About This Guide

---

## Introduction

This document is intended for those who wish to setup and operate the FX9500 RFID Reader system. Before attempting to install, configure, and operate this product, you should be familiar with the following:

- Windows-based software installation and operation
- Device communication parameters including Ethernet and serial communications
- RFID reader configuration including antenna placement
- Basic digital input/output control.

✓ **NOTE** Screens and windows pictured in this guide are samples and may differ from actual screens.

---

## Configurations

This guide covers the following FX Series of RFID reader configurations:

- US and Canada 4-port configuration, part number: FX9500-41324D41-US
- International 4-port configuration, part number: FX9500-41324D41-WW
- US and Canada 8-port configuration, part number: FX9500-81324D41-US
- International 8-port configuration, part number: FX9500-81324D41-WW.

---

## Chapter Descriptions

Topics covered in this guide are as follows:

- [Chapter 1, Getting Started](#) - This chapter provides a brief overview of the FX9500 RFID Reader hardware and software.
- [Chapter 2, RFID Reader Installation](#) - This chapter describes how to mechanically and electrically install the FX9500 RFID Reader.
- [Chapter 3, RFID Reader Operation](#) - This chapter provides the FX9500 RFID Reader operation instructions.
- [Chapter 4, Embedded Web Console](#) - This chapter provides information on how to fully configure the FX9500 RFID Reader for operation in a variety of applications and environments.
- [Chapter 5, Configuring Digital Inputs and Outputs](#) - This chapter provides information on how to configure the FX9500 RFID Reader Digital Inputs and Outputs.
- [Chapter A, Technical Specifications](#) - This appendix provides detailed mechanical, electrical, and environmental specifications.
- [Chapter B, Safety Instructions](#) - This appendix provides important safety information about the FX9500 RFID Reader. All users must read this section before installing or operating this reader.
- [Chapter C, Disposal of Reader](#) - This appendix provides instruction for removing the battery and disposing of the reader.

---

## Notational Conventions

The following conventions are used in this document:

- “RFID Reader” or “reader” refers to the Motorola FX9500 RFID reader.
- *Italics* are used to highlight the following:
  - Chapters and sections in this guide
  - Related documents.
- **Bold** text is used to highlight the following:
  - Code entered by the user
  - Dialog box, window and screen names
  - Drop-down list and list box names
  - Check box and radio button names
  - Icons on a screen
  - Key names on a keypad
  - Button names on a screen.
- Bullets (•) indicate:
  - Action items
  - Lists of alternatives
  - Lists of required steps that are not necessarily sequential.
- Sequential lists (e.g., those that describe step-by-step procedures) appear as numbered lists.
- Values in () indicate:
  - (values) within parentheses indicate parameters
  - (*values*) in italics indicate user defined variables.
- <n> indicates a variable number used in a function that can apply to several different devices such as antennas or I/O ports.

---

## Related Documents and Software

The following documents provide more information about the FX9500 RFID reader.

- *FX9500 Regulatory Guide*, p/n 72-152143-xx
- RFID API 1.1

For the latest version of this guide and all guides, go to: <http://supportcentral.motorola.com>.

---

## Service Information

If you have a problem with your equipment, contact Motorola Solutions support for your region. Contact information is available at: <http://supportcentral.motorola.com>.

When contacting Motorola Solutions support, please have the following information available:

- Serial number of the unit
- Model number or product name
- Software type and version number

Motorola responds to calls by e-mail, telephone or fax within the time limits set forth in service agreements.

If your problem cannot be solved by Motorola Solutions support, you may need to return your equipment for servicing and will be given specific directions. Motorola is not responsible for any damages incurred during shipment if the approved shipping container is not used. Shipping the units improperly can possibly void the warranty.

If you purchased your business product from a Motorola business partner, please contact that business partner for support.

# Chapter 1 Getting Started

---

## Introduction

This chapter provides a brief overview of the FX9500 RFID Reader hardware and software.

## RFID Reader Hardware

The FX9500 RFID Reader is a multi-protocol, multi-regional Radio Frequency Identification (RFID) System that operates in the 902-928 MHz and 865-868 MHz band.

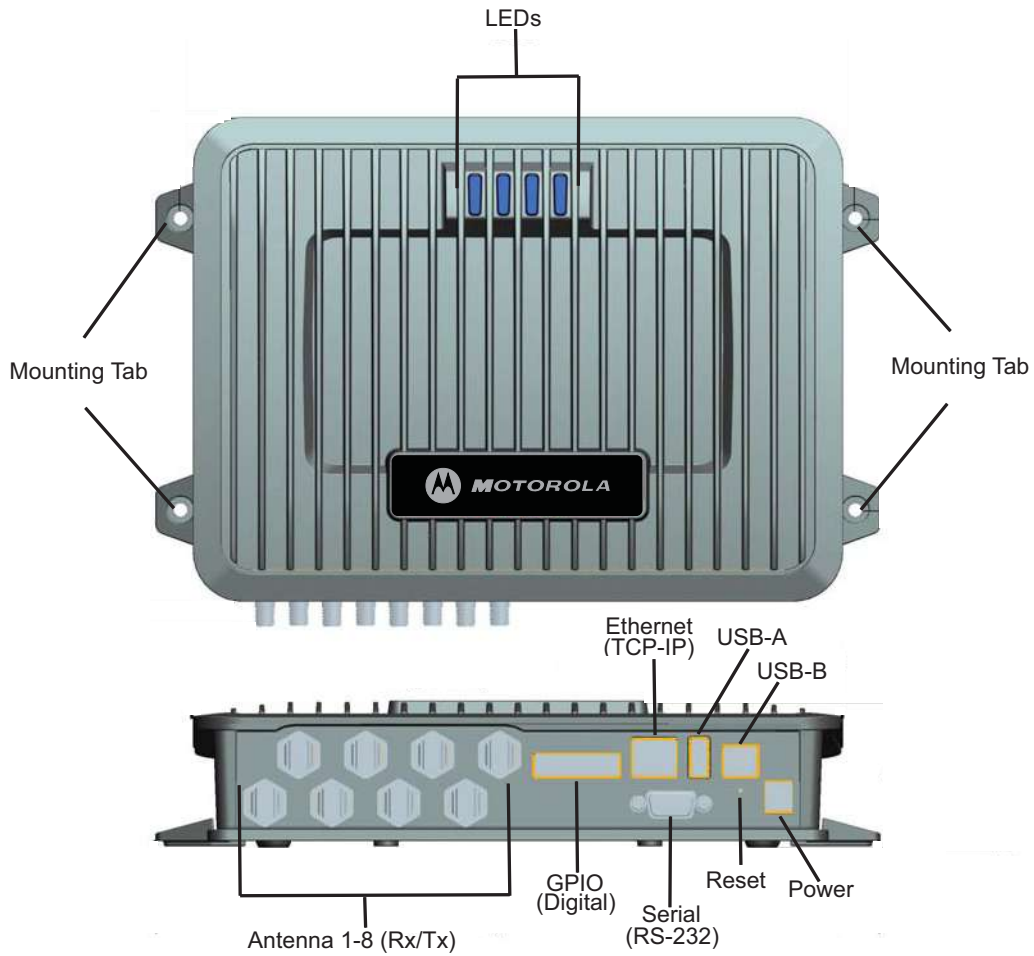

**Figure 1-1** FX9500 RFID Reader



As shown in [Figure 1-2](#), the high performance FX9500 RFID Reader supports up to eight Tx/Rx antennas (8x1 monostatic or 4x2 bistatic) and is equipped with RS-232, USB 2.0, and Ethernet interfaces. Discrete digital inputs and outputs are also provided.



**Figure 1-2** FX9500 Power and I/O Connections

- ✓ **NOTE** The eight (8) port FX9500 RFID Reader illustrated above also is available in a four (4) port configuration (see [Configurations on page 3-ix](#)).

The FX9500 RFID Reader is equipped with four status indicators located on the top of the enclosure. These LEDs provide indication for the following:

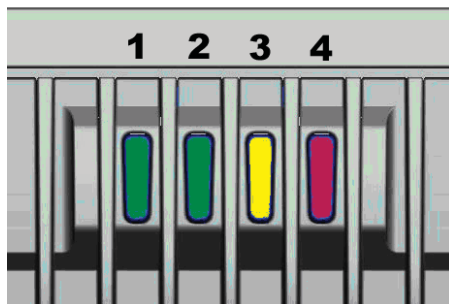

**Figure 1-3** FX9500 RFID Reader Status Indicators

**Table 1-1**

Number	Indication	Color/State	Indication
1	Power	Off Amber Amber-Flashing Green	Power off Boot loader executing Linux initializing Unit operational
2	Activity	Off Green Green-Flashing Amber	RF off TX active Tag detect Antenna check failed
3	User	Amber	User defined
4	Status	Off Amber Green-Flashing Red	OK Firmware update GPIO activity Fault

---

## Reader Software

The FX9500 is shipped with a software application that can be used to configure and control the RFID Reader.

### Embedded RFID Reader Web Console

The Web Console is an embedded RFID Reader application that provides the ability to access RFID Readers across the internet. Enter the IP address of the RFID Reader into a web browser, Web Console and RM interface allows you to fully modify and operate the RFID Reader. This application provides the ability to modify the RFID Reader's communication, network, and operational parameters. Also, the ability to read tags, review tag data, perform diagnostics, and upload new software. This application is primarily intended for configuring and managing deployed RFID Readers. For detailed information, see [Chapter 4, Embedded Web Console](#).

# Chapter 2 RFID Reader Installation

---

## Introduction

This chapter describes how to mechanically and electrically install the FX9500 RFID Reader.

## Mechanical Installation

### Mounting the RFID Reader

The FX9500 is equipped with two mounting flanges and slotted keyholes that accept three #8 (M4) mounting screws. Pre-drill mounting surface according to the following dimensions. The mounting surface must be able to support up to 5 pounds (2.3 kg).



**IMPORTANT** The FX9500 RFID Reader has been designed and tested to meet all regulatory requirements in the jurisdiction where offered. Any attempt to open the reader housing or modify the reader in any way, will void the reader warranty and may violate regulatory requirements. Contact Motorola Support for additional information.

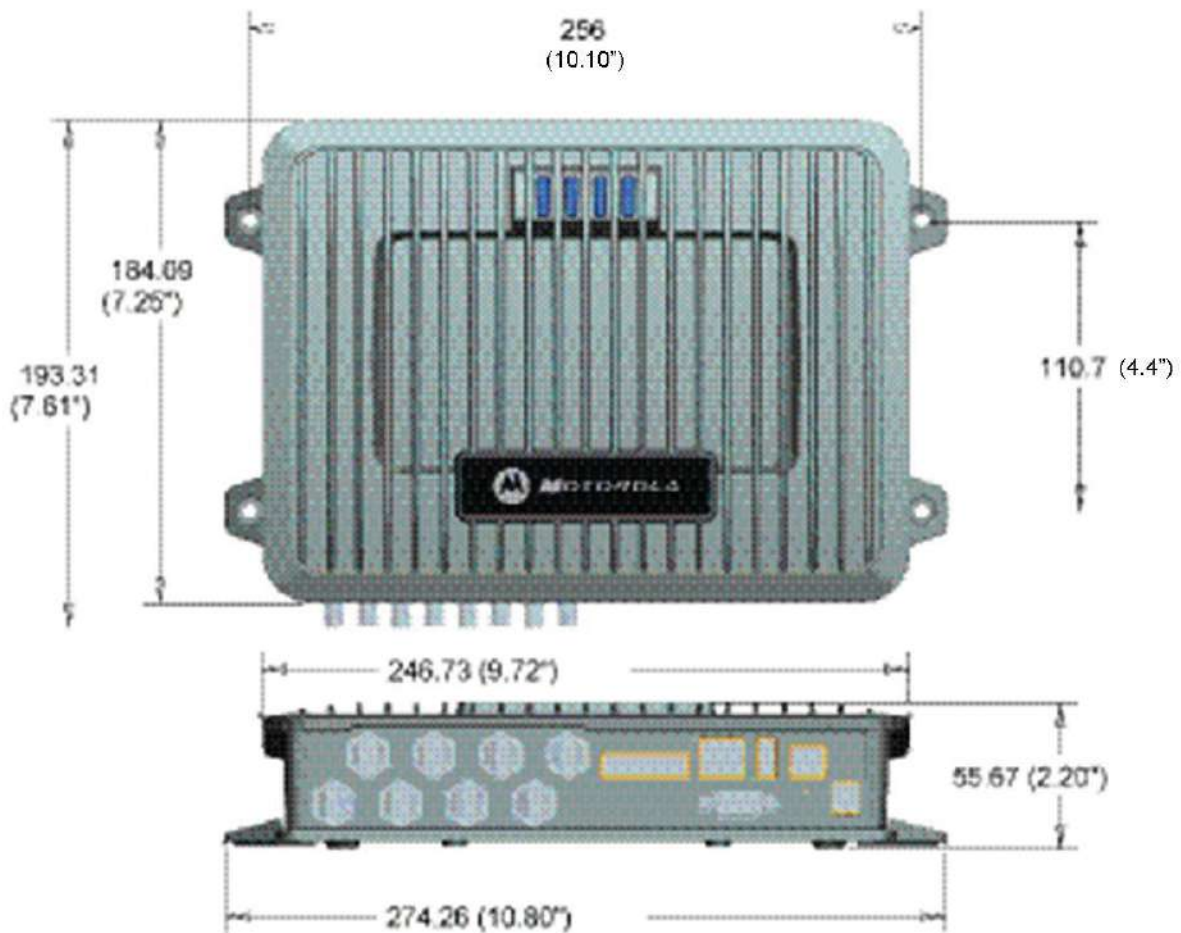

**Figure 2-1** FX9500 Mechanical Dimensions (dimensions in mm)

### Concrete Wall Mounting

To mount the RFID Reader to a hollow concrete block wall, Motorola recommends metal sleeve type concrete anchors that accept #8 screws and flat washers.

### Wood or Metal Wall Mounting

To mount the RFID Reader to a wood or sheet metal wall, Motorola recommends either #8 x 1 inch wood screws or #8 x 1 inch sheet metal screws and washers.

### Drywall Mounting

To mount the RFID Reader to drywall or sheetrock, Motorola recommends either #8 toggle bolts or #8 drywall anchors.

## Mounting the Antennas

The FX9500 RFID Reader supports from one to eight antennas in a variety of configurations. One and two-antenna configurations are typical for most conveyor and container tracking. Four and eight antenna configurations are used for portals and loading dock doorways.

Antennas (not provided) must be installed on a solid surface or frame to prevent damage or later misalignment. It is highly recommended that the antenna mounting be adjustable in order to obtain the best performance from the system.



**WARNING!** FCC Radiation Exposure Statement. The antennas used for this transmitter must be installed to provide a separation distance of at least 25 cm from all persons and must not be co-located or operating in conjunction with any other antenna or transmitter.

EU Radiation Exposure Statement. The antennas used for this transmitter must be installed to provide a separation distance of at least 25 cm from all persons and must not be co-located or operating in conjunction with any other antenna or transmitter.

## Electrical Installation

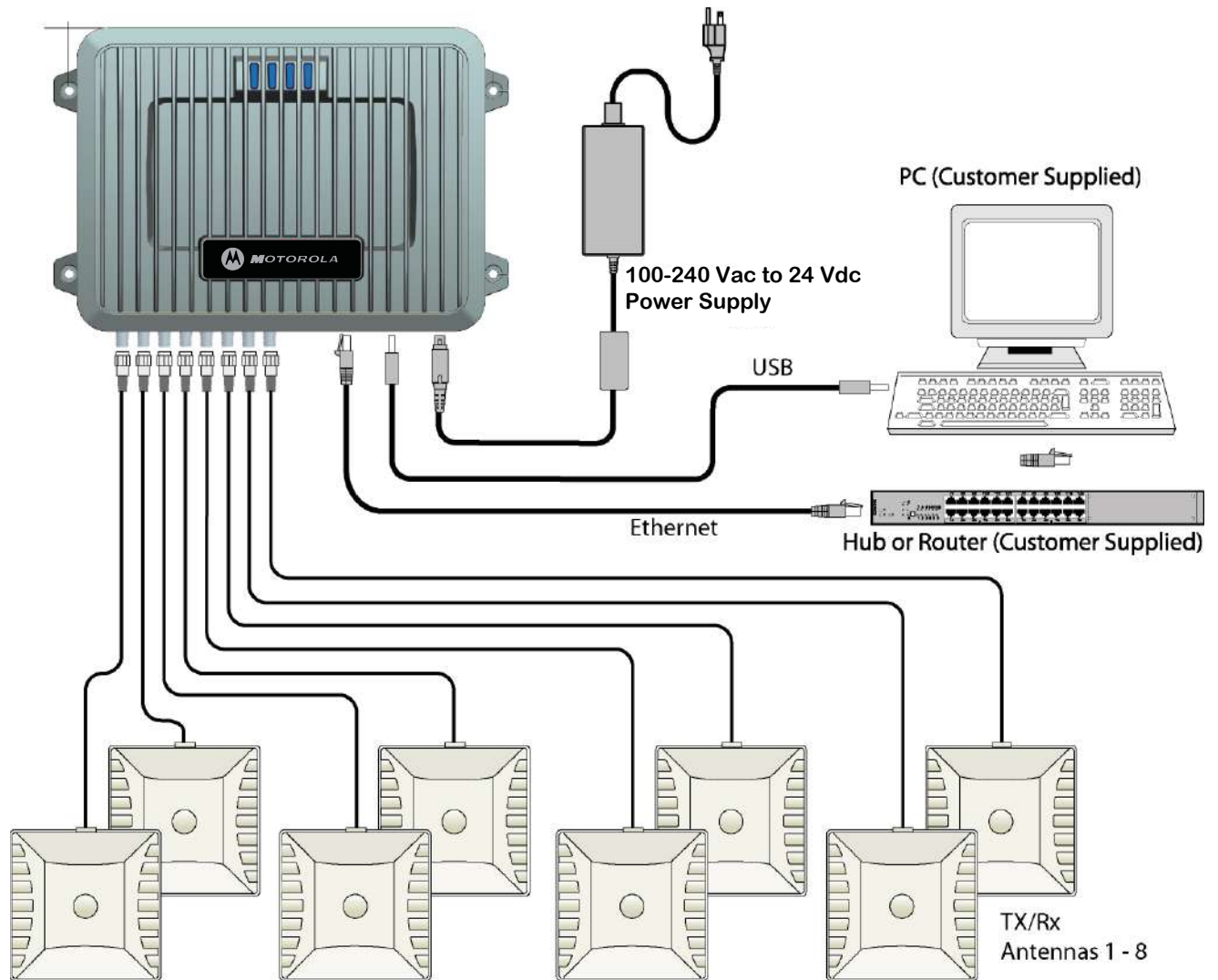

**Figure 2-2** FX9500 Electrical Connections



**NOTE** The FX9500 RFID Reader is designed to meet the regulatory requirements in those jurisdictions in which it is offered. Changes or modifications not expressly approved by Motorola for compliance could void the user's authority to operate the equipment.



**IMPORTANT** FX9500 RFID Reader antenna ports may be susceptible to damage from static discharge or other high voltage. Use proper Electrostatic Discharge (ESD) precautions to avoid static discharge when handling or making connections to the FX9500 RFID Reader antenna or communication ports. Equipment failure can result if the antenna or communication ports are subjected to ESD.

## Connecting the Serial Port

The FX9500 RFID Reader is equipped with one DB9 type RS-232 serial port for communication up to 115200 Baud. If using the serial port for RFID Reader communication, connect a serial cable from the COM port on the PC to the serial port on the RFID Reader. The maximum serial cable length is 12 feet at 115200 Baud.

## Connecting the USB Ports

The FX9500 RFID Reader is equipped with two USB 2.0 ports. The USB Type B port provides connectivity to the FX9500 console. This connection is used to send commands and receive responses and is typically connected to your server. The USB Type A port is used for external devices such as printers, external hard drives, or other peripherals.

For standard communications, connect a USB Type B cable to the RFID Reader and then to your PC or server. The maximum cable length is 5 meters to the nearest hub, router, or computer.

## Connecting and Configuring the Ethernet Port

The maximum Ethernet cable length is 30 meters. If communicating with the RFID Reader across a Local Area Network (LAN), connect an Ethernet cable from the hub or router to the RJ-45 connection.

By default, the RFID Reader is configured to use a DHCP server to obtain its IP address and related information. In the event a DHCP server is unavailable, the RFID Reader will boot with an IP address in the 169.254.x.x subnet.

In the absence of other RFID Readers on the same network, and if no other network traffic is observed which references 169.254.1.1, the RFID Reader will select that address; otherwise, it will select a random address on the 169.254.x.x subnet.

## Connecting the Antennas

The maximum antenna cable length is 10 meters. Connect the antenna to antenna port 1. If using additional antennas, connect them to Ports 2-8.

Antennas can be connected as either 8x1 monostatic or 4x2 bistatic.



**IMPORTANT** Always power down the RFID Reader through the web console before removing an antenna or load from an RF port.



**NOTE** The FX9500 RFID Reader antenna ports may be susceptible to damage from static discharge or other high voltage. Use proper Electrostatic Discharge (ESD) precautions to avoid static discharge when handling or making connections to the FX9500 RFID Reader antenna or communication ports. Equipment failure can result if the antenna or communication ports are subjected to ESD.



## Connecting Digital Inputs/Outputs

The FX9500 RFID Reader is equipped with a general purpose digital input/output (I/O) port that provides four optically isolated 5-24 Vdc input signals and four open-collector output signals. The digital inputs can be used as general purpose inputs or to trigger the RFID Reader for tag reading. These inputs can be configured to provide an external read trigger from proximity sensors, photo switches, or other devices.

The digital outputs can be used as general purpose outputs, to indicate tag reading activity, or to indicate the RFID Reader is transmitting (RF On). The outputs can also be configured to trigger conveyor gates or other access control and sorting devices. For detailed information on configuring the digital inputs and outputs, see [Chapter 5, Configuring Digital Inputs and Outputs](#).

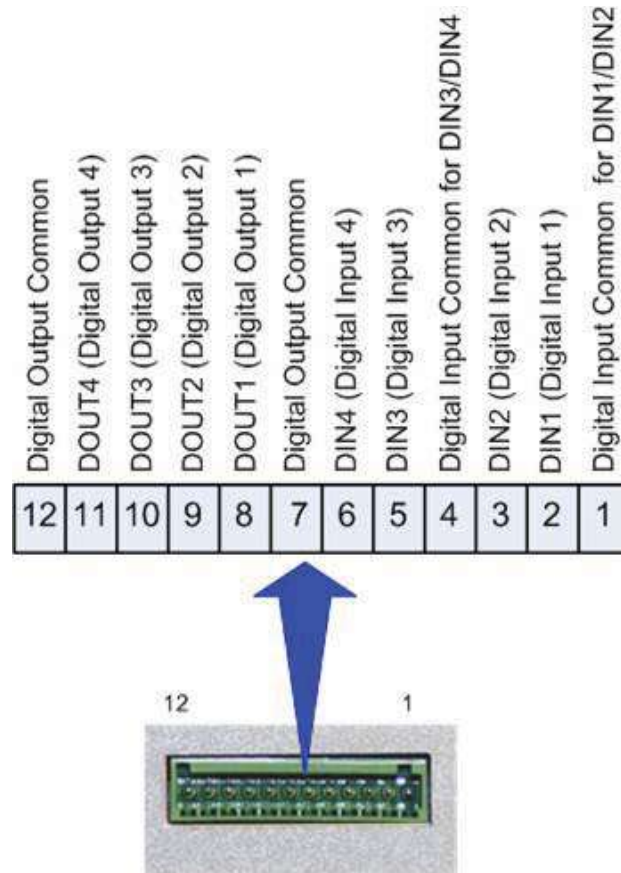

Figure 2-3 Digital Input/Output

## Connecting the Power

Connect the 24 Vdc power supply to the RFID Reader and connect the power supply to your 100-240 Vac, 50-60 Hz power source. Allow 30 seconds for the RFID Reader to initialize.



# Chapter 3 RFID Reader Operation

## Introduction

This chapter provides operation instructions for the FX9500 RFID Reader.

## RFID Reader Operation with Web Console

The FX9500 can be operated by logging directly into the RFID Reader's embedded Web Console. To access a particular RFID Reader, perform the following:

1. Enter the RFID Reader's IP address into your web browser or press the **Configure** button.
2. The RFID Reader's Web Console interface is displayed.



Figure 3-1 Web Console Interface Screen

- Log into the RFID Reader. Press **Login** for the login screen.

Name	Value	?
Login	admin	?
Password	*****	?

**Figure 3-2** Login Screen

- The default login is **guest**. If you need administrator privileges, login as **admin** and enter **change** as the password.
- Press **Submit**.
- Select **Basic Configuration**, then **Setup Antenna/Cables** to configure the antennas, gain, and power settings.
- Select **Advanced Functions**, then **Change Operating Mode** to verify the RFID Reader is in the proper mode.
- Select **Basic Configuration**, then **Set Tag Protocol** to verify the RFID Reader is configured for the proper tag protocol.
- Press **System Status**, then **View Tags** to view tag data.

Tag ID	Protocol	Antenna	Repeat Counts	First Read Time	Last Read Time
0x03040208000000000000000016335	ISOC	4	25	2009-06-02T21:08:54.865	2009-06-02T21:08:57.178
0x03040208000000000000000016336	ISOC	3	12	2009-06-02T21:08:54.954	2009-06-02T21:08:57.045
0x03040208000000000000000016337	ISOC	4	25	2009-06-02T21:08:54.876	2009-06-02T21:08:57.176
0x03040208000000000000000016338	ISOC	4	25	2009-06-02T21:08:54.868	2009-06-02T21:08:57.178
0x03040208000000000000000016354	ISOC	4	25	2009-06-02T21:08:54.900	2009-06-02T21:08:57.176
0x03040208000000000000000016355	ISOC	4	13	2009-06-02T21:08:54.848	2009-06-02T21:08:57.175

Polling Period (seconds):

**Figure 3-3** View Tag Data Screen

- If you need to configure your RFID Reader, see [Chapter 4, Embedded Web Console](#) for information on using Web Console to adjust configuration variables and parameters.

## Change Password

The `reader.set_pwd()` command is used to change the password. This command requires the following parameters:

- Login (level for password to be changed)
- Pwd (existing password for the login level)
- New\_pwd (new password for the login level).

The login and existing password are required to change the password. For example, to change the initial password for the guest login level to **19qht34** use the following command:

```
> reader.set_pwd(guest, readerguest, 19qht34)
```

ok

- ✓ **NOTE** To prevent unauthorized reader access, it is strongly recommended that the default **guest** login and **admin** password are changed.



# Chapter 4 Embedded Web Console

---

## Introduction

This chapter provides information on how to fully configure the FX9500 RFID Reader for operation in a variety of applications and environments.

## Embedded Web Console

The embedded Web Console allows access to a RFID Reader across the internet by entering the Reader's IP address into the web browser. With the Web Console, the RFID Reader can fully be configured for operation in a variety of applications and environments. The following options are available in this application:

- Basic Configurations
- Advanced Configurations
- Check System Status
- Access the online Help.



Figure 4-1 Web Console Interface Screen



---

## Basic Configuration

With the Basic Configuration functions you can perform the following:

- Manage reader profiles
- Set tag protocols
- Setup the Ethernet/LAN configuration
- Setup the serial port
- Setup digital accessories
- Setup antennas
- Set regulatory modes.

---

## Configuration Page Header

Each page displayed by the Web Console has the following header.



**Figure 4-2** Web Console Header

This header provides pull-down menus for each of the configuration function categories. Additional functions include the user login and the currently loaded reader profile.

### Login

The reader's default user level is **guest**. However, a user can login as **admin**. If not logged in as **admin**, the default level is always **guest**.

The guest login level provides read-only access to the reader. Clients that login in at the guest level can read the settings of the reader and can access the tags that the reader has inventoried. Clients at this level cannot change the configuration of the reader.

The admin login level provides read-write access to the reader. Clients that login in at the admin level can read and write the settings of the reader and can access the tags that the reader has inventoried.

- ✓ **NOTE** The FX9500 RFID Reader has the ability to support multiple unique connections with the same log-in credentials. Additional user accounts can be created with admin privileges in order to allow access to the admin account in the event a password is forgotten or lost.

### Logout

After logging in as **admin**, the **Logout** button logs out of the reader. Logging out automatically sets the login level to guest.

## Profile

**Profile** is the currently active profile in the reader (see [Manage Profiles on page 4-4](#) for detailed information on reader profiles).

## Save

The **Save** button saves the reader's current configuration to the specified profile (see [Manage Profiles](#) for detailed information on reader profiles).

## Manage Profiles

The **Manage Profiles** link lists, saves, and deletes profiles. Refer to the [Manage Profiles](#) section for detailed information on reader profiles.

## Manage Profiles



The reader's configuration is stored in a profile. A profile contains the setting of all the configuration variables in the reader. The reader can support up to 8 unique profiles.

The **Manage Profiles** page provides a list of all profiles stored in the reader.

Save reader configuration state and set new current profile as:

Profile Name	Activate	Delete	?
avi	<input type="button" value="Activate"/>	<input type="button" value="Delete"/>	?
portal	<input type="button" value="Activate"/>	<input type="button" value="Delete"/>	?

**Factory Defaults**

Reset Factory Profile

Stop All Embedded Applications

Reset Serial Port

Reset Network Interface Configuration

**Figure 4-3** Manage Profiles Page

## Save a Profile

To save the current reader configuration under a new profile, enter a profile name and press **Save**. The new profile will appear in the **Profile Name** list. Profile names must consist of the characters A - Z, a - z, 0 - 9, '-' or '\_' and must be between 1 and 32 characters in length. The reader can store up to 8 different profiles.



**NOTE** The profile name **factory** is reserved and cannot be used. This profile is a read only profile.

## Activate a Profile

To activate a previously saved profile, press the **Activate** button beside the profile name. The selected profile will be loaded into the reader.

## Delete a Profile

To delete a previously saved profile, press the **Delete** button beside the profile name. Once a profile is deleted, it cannot be recovered.



**IMPORTANT** Deleting a profile is a destructive operation. Profiles cannot be recovered once they have been deleted.

---

## Set Tag Protocol



The **Set Tag Protocol** page consists of two forms. The first form (top) allows you to select which type of tags the reader will acquire or the type of protocol(s) to utilize on the air interface. Currently, the reader can operate with either ISO18000-6B (ISOB), ISO18000-6C (ISOC), SuperTag, EASAlarm, or any combination of the four.

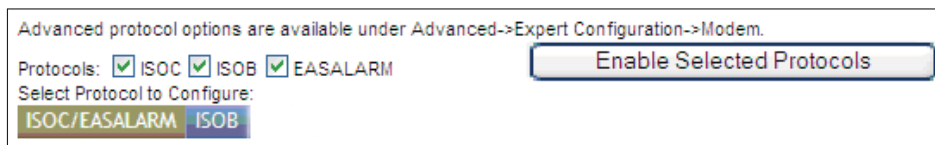

**Figure 4-4** *Set Tag Protocol Screen*

Select the check box for the protocol(s) to enable and then press **Enable Selected Protocols** to activate the protocol.

Click on a specific protocol to view the lower form. This form allows you to configure various protocol level parameters. The protocol level parameters are divided into two categories: **Control** and **Physical**. **Control** parameters configure the protocol control. **Physical** parameters configure the physical air interface for the protocol.

## Control

Name	Value	?
Command Retried	<input type="text" value="3"/>	?
Display Tag CRC	<input type="text" value="false"/>	?
Mem Bank For Selection	<input type="text" value="membank_epc"/>	?
Number Slots Q	<input type="text" value="0"/>	?
Select Cmd Period	<input type="text" value="0"/>	?
Session ID	<input type="text" value="session_1"/>	?
Transmit Attenuation	<input type="text" value="0"/>	?
User Block Write	<input type="text" value="false"/>	?

## Physical

Name	Value	?
Mode	<input type="text" value="4 - Miller4/LF240/12.5tari/PR_ASK"/>	?
Modulation Depth	<input type="text" value="90"/>	?
Pilot Tone	<input type="text" value="true"/>	?

**Figure 4-5** Control Protocol/Physical Protocol Screens

## Setup Ethernet/LAN

The Setup Ethernet/LAN page configures the network interface of the reader.



### General Settings

Name	Value	?
Host Name	ABCDEFGH	?
Command Port	50007	?
Event Port	50008	?
Domain Name		?
Mac Address		?

### IPv4 Settings

Name	Value	?
Method	dhcp	?
IP Address	10.1.1.54	?
Subnet Mask	255.255.255.0	?
Default Gateway	10.1.1.1	?

### IPv6 Settings

Name	Value	?
Method	static	?
IP Addresses	aa::205/64	?
Default Gateway	none	?

### Other Settings

Name	Value	?
NTP Servers	Platform 1	?
DNS Servers	10.1.1.2 10.1.1.18	?
Domain List		?

Figure 4-6 Setup Ethernet/LAN Screen

- ✓ **NOTE** Always record and keep the following items in a safe location: IP, Mac, subnet, and default gateway addresses. This data can be used to reconfigure the network in the event of application failure or data loss.

## General Settings

**General Settings** specify the host and domain name of the reader. Also, the **Command Port** and **Event Port** are shown and are read-only.

## IPv4/IPv6 Settings

**IPv4/IPv6 Settings** configure the reader's IP address. If the reader is to automatically acquire its IP address, subnet mask and default gateway from a DHCP server, select **Enable DHCP**. To manually specify this information, deselect **Enable DHCP** and fill in the desired IP address, subnet mask and default gateway.

## Other Settings

**Other Settings** offer the ability to configure the **NTP servers** the reader can contact to obtain the current time, **DNS servers** the reader can contact for domain name resolution, and the **Domain list** to resolve names to IP addresses.

Enter all the required information and press **Submit**.

## Setup Serial Port



The **Setup Serial Port** function configures of the serial port parameters. These parameters include:

- Baud rate
- Data bits
- Parity
- Echo
- Stop bits.

Name	Value	?
Baudrate	115200 ▾	?
Data Bits	8 ▾	?
Parity	NONE ▾	?
Echo	true ▾	?
Stopbits	1 ▾	?

**Figure 4-7** Setup Serial Port Screen

Use the pull-down menus to select a value and press **Submit** to update the reader.

## Setup Digital Accessories



The Setup Digital Accessories function configures the Digital Inputs and Outputs on the reader.

### Digital Input

Name	Current Value	Debounce	?
1	true	30	?
2	true	30	?
3	true	30	?
4	true	30	?

### Digital Output

Name	Current Value	?
1	false	?
2	false	?
3	false	?
4	false	?

Submit Reset

Figure 4-8 Setup Digital Accessories Screen

### Digital Input

The status of the four digital input values (1-4) can be seen in this window. The Current Value is not configurable and is shown as **true** or **false**. The Debounce value can be set and is in milliseconds.

### Digital Output

The output value for each digital output can be set to **true** or **false**. Press the **Submit** button to send the appropriate commands to the reader.



## Setup Antenna/Cables

 **Basic Configuration**

- Manage Profiles
- Set Tag Protocol
- Setup Ethernet/LAN
- Setup Serial Port
- Setup Digital Accessories
- Setup Antenna/Cables
- Set Regulatory Mode (Region)
- Setup Summary

Use this option to configure the reader's antenna multiplexer sequence as well as, conducted power.

To configure an antenna, enter the antenna number in the **Mux Sequence** field. The individual antenna **Conducted Power** fields will be activated in the lower window. The current values will be displayed. Only those antennas listed in the **Mux Sequence** will be shown. Also, you must set **Conducted Power** to **0** in order to set or change the **Attenuation**, **Cable Loss**, or **Gain**.

To change, enter the appropriate values for each antenna parameter and press the **Submit** button to update the antenna and cable configuration. Select the next antenna and repeat.

Name	Value	?
Detected Antennas	<input type="text" value="12"/>	?
Port Count	<input type="text" value="8"/>	?
Mux Sequence	<input type="text" value="1"/>	?

This table provides information related to the individual antennas.

Name	Antenna 1	Antenna 2	Antenna 3	Antenna 4	?
Conducted Power	<input type="text" value="0"/>	<input type="text" value="0"/>	<input type="text" value="0"/>	<input type="text" value="0"/>	?
Attenuation	<input type="text" value="0"/>	<input type="text" value="0"/>	<input type="text" value="0"/>	<input type="text" value="0"/>	?
Cable Loss	<input type="text" value="10"/>	<input type="text" value="10"/>	<input type="text" value="10"/>	<input type="text" value="10"/>	?
Gain	<input type="text" value="60"/>	<input type="text" value="60"/>	<input type="text" value="60"/>	<input type="text" value="60"/>	?
Gain Units	<input type="text" value="dbdc"/>	<input type="text" value="dbdc"/>	<input type="text" value="dbdc"/>	<input type="text" value="dbdc"/>	?
Computed Conducted Power	<input type="text" value="310 (ddBm), 1.26 (W)"/>	<input type="text" value="310 (ddBm), 1.26 (W)"/>	<input type="text" value="310 (ddBm), 1.26 (W)"/>	<input type="text" value="310 (ddBm), 1.26 (W)"/>	?

Name	Antenna 5	Antenna 6	Antenna 7	Antenna 8	?
Conducted Power	<input type="text" value="0"/>	<input type="text" value="0"/>	<input type="text" value="0"/>	<input type="text" value="0"/>	?
Attenuation	<input type="text" value="0"/>	<input type="text" value="0"/>	<input type="text" value="0"/>	<input type="text" value="0"/>	?
Cable Loss	<input type="text" value="10"/>	<input type="text" value="10"/>	<input type="text" value="10"/>	<input type="text" value="10"/>	?
Gain	<input type="text" value="60"/>	<input type="text" value="60"/>	<input type="text" value="60"/>	<input type="text" value="60"/>	?
Gain Units	<input type="text" value="dbdc"/>	<input type="text" value="dbdc"/>	<input type="text" value="dbdc"/>	<input type="text" value="dbdc"/>	?
Computed Conducted Power	<input type="text" value="310 (ddBm), 1.26 (W)"/>	<input type="text" value="310 (ddBm), 1.26 (W)"/>	<input type="text" value="310 (ddBm), 1.26 (W)"/>	<input type="text" value="310 (ddBm), 1.26 (W)"/>	?

Figure 4-9 Antenna/Cable Setup Screen

## Set Regulatory Mode (Region)



Use this mode to configure the reader to meet the regulatory requirements for the geographic region where the reader is deployed. The sub-region sets the secondary regulatory mode for the geographic region where the reader is deployed.

Name	Value	?
Region	unselected	?
Sub Region	unselected	?

Figure 4-10 Regulatory Mode Screen



**IMPORTANT** Select only the country in which you are using the device. Any other selection will make the operation of this device illegal.

Select your Region.

Name	Value	?
Region	unselected	?
Sub Region	unselected	?

- unselected
- argentina
- australia
- brazil
- china
- etsi
- hongkong
- india
- israel
- japan
- jordan
- korea
- malaysia
- mexico
- newzealand
- philippines
- russia
- saudi Arabia
- singapore
- south africa
- taiwan
- thailand
- turkey
- uae
- uruguay
- venezuela
- vietnam

Figure 4-11 Regulatory Mode - Select Region

Select the Sub Region.

Name	Value	?
Region	unselected	?
Sub Region	unselected argentina_dense australia_4w_dense brazil china en302208_dense etsi_expand_1 hongkong_band_1_dense hongkong_band_2_dense india_dense israel_dense std_t106_2011_shift std_t106_2011_dense std_t106_2011_low_dense jordan_dense korea_fhss_dense malaysia_dense mexico_dense newzealand_dense philippines_dense russia_dense saudi_dense singapore_band_2_dense southafrica_band_2 taiwan_dense thailand_dense uae_dense uruguay_dense venezuela_dense vietnam_dense	?

Reset

Figure 4-12 Regulatory Mode - Select Sub Region

## Setup Summary

Quickly setup the basic operational parameters of the reader in **Setup Summary**.

Name	Value	?
Region	fcc	?
Sub Region	fcc_dense	?
Install Type	portal	?
Tag Volume	16_32	?
Protocols	<input checked="" type="checkbox"/> ISOC <input type="checkbox"/> ISOB <input type="checkbox"/> SUPERTAG <input type="checkbox"/> EASALARM	?

## Antenna Selection

Name	Value	?
Antennas	<input checked="" type="checkbox"/> 1 <input type="checkbox"/> 2 <input type="checkbox"/> 3 <input type="checkbox"/> 4 <input type="checkbox"/> 5 <input type="checkbox"/> 6 <input type="checkbox"/> 7 <input type="checkbox"/> 8	?

Figure 4-13 Setup Summary Screen

## Advanced Functions



The following options are available in Advanced Functions:

- Firmware Management
- Import/Export Configuration
- Command Line operations
- Expert Configuration
- User Application Management
- Change Operating Mode
- Restart.

## Firmware Management

Use the Firmware Management option to read the current firmware version, upgrade the reader firmware files, or rollback to the previous firmware version.

To upgrade reader firmware, enter the name of the Motorola provided firmware file in the **Firmware File** field. Use the **Browse** button to help locate the file. Once the filename is entered, press **Upgrade Firmware**.

The same method is used to upgrade the LLRP Component firmware. Use the **Browse** button to help locate the file. Once the filename is entered, press **Update Component**.

The **Rollback Firmware** button will roll back the firmware to the previous version.

 A screenshot of the "Firmware Management" screen. It is divided into three sections:
 

- Upgrade Firmware:** Shows "Current Firmware version: 0.6.trunk\_rel\_17227". It has a text input field for "Firmware File:" with a "Browse..." button and a question mark icon. Below it is an "Upgrade Firmware" button.
- Rollback Firmware:** Shows "Firmware rollback version: 0.6.trunk\_rel\_17215". It has a "Rollback Firmware" button with a question mark icon.
- LLRP Component Firmware:** Shows "Current Component version: 279". It has a text input field for "Update File:" with a "Browse..." button and a question mark icon. Below it is an "Update Component" button.

Figure 4-14 Firmware Management Screen

## Import/Export Configuration

This option transfers a reader configuration to or from a host computer. This is useful for configuring a reader to a known state.

### Transfer a Configuration File

Enter the name of a saved configuration file in the **Configuration file** field. Select the **XML File** option and press the **Transfer Configuration to Reader** button to send the profile to the reader.

### Export Configuration File to Reader

This function is used to export the current reader settings for later uploading. Press the **XML Format** button to view the XML file in the browser. To retain the file for future reference, save the file.

To view the current configuration parameters for a reader, press **Text Format** button.

### Import Security Keys

To import reader security keys, navigate to the key file and press **Import Security Keys** to load the file into the reader.

✓ **NOTE** The **Import License** feature is not supported. Therefore, disregard the Import License section shown in [Figure 4-15](#).

The screenshot displays a web interface with four main sections:

- Import Configuration to Reader:** Includes a text input for 'Configuration file:' with a 'Browse...' button, radio buttons for 'XML File' (selected) and 'Text File', and an 'Import Configuration' button.
- Export Configuration from Reader:** Features two buttons: 'XML Format' and 'Text Format'.
- Import Licenses:** Contains a text input for 'License file:' with a 'Browse...' button and an 'Import License' button.
- Import Security Keys:** Contains a text input for 'Key file:' with a 'Browse...' button and an 'Import Security Keys' button.

**Figure 4-15** Import/Export Configuration Screen

## Command Line

Use **Command Line** to directly enter reader commands from a web browser.



A screenshot of the Command Line interface. It features a text input field labeled "Command:" with a "Send" button to its right. Below the input field is a large, empty rectangular area labeled "Response:".

**Figure 4-16** *Command Screen*

## Expert Configuration



Use the Expert Configuration functions to configure low-level functions within the reader. These functions should only be accessed by expert users. Expert configurations include:

- Setup
- Tag
- Version
- Information
- Communication
- Antennas
- Digital I/O
- Modem.

### Expert Configuration - Setup

Use **Expert Configuration - Setup** to set the basic operating parameters of the reader including region, sub region, mode, and active protocols. Also, view the valid protocols and regions.

Name	Value	?
setup.default_login_level	guest	?
setup.install_type	portal	?
setup.operating_mode	standby	?
setup.protocols	isoc isob	?
setup.region	fcc	?
setup.sub_region	fcc_a	?
setup.sub_region_class	na	?
setup.tag_volume	4_8	?
setup.valid_protocols	isoc isob supertag easalarm	?
setup.valid_regions	australia brazil china etsi fcc hongkong india israel japan	?
setup.valid_sub_regions	australia australia_dense brazil_band_1 brazil_band_2 br	?
setup.advanced.preferred_frequencies	0	?

Figure 4-17 Expert Configuration Screen

## Expert Configuration - Tag



Use the **Expert Configuration - Tag** option to configure how the reader reports tags.

The FX9500 supports the ability to filter tags or eliminate tags from being reported based on the conditions specified in the filter configuration variables. The reader supports eight filters and each filter is specified by the following configuration variables:

- **Enabled** - Enables or disables the filter.
- **Inclusive** - Indicates to either include tags that match (inclusive) or include tags that do not match (exclusive) the tag filter.
- **Mask** - Mask (as an array of hex bytes) for the tag filter.
- **Name** - Name given to the tag filter
- **Pattern** - Pattern (as an array of hex bytes) for the tag filter.

The following figure shows a small sample of the available variables.

Name	Value	?
tag.db.max_count	10000	?
tag.db.max_user_data	32	?
tag.filter.1.enabled	false	?
tag.filter.1.inclusive	true	?
tag.filter.1.mask	00	?
tag.filter.1.name		?
tag.filter.1.pattern	00	?
tag.reporting.antenna_cross_fields	tag_id antenna	?
tag.reporting.arrive_fields	tag_id	?
tag.reporting.depart_fields	tag_id	?
tag.reporting.depart_time	1000	?
tag.reporting.raw_tag_data	false	?
tag.reporting.report_fields	tag_id rssi	?
tag.reporting.report_write_verify	false	?
tag.reporting.taglist_fields	tag_id repeat antenna time type	?
tag.reporting.ambient.enabled	false	?
tag.reporting.antenna_cross.enabled	false	?
tag.reporting.antenna_cross.max_speed	10	?
tag.reporting.antenna_cross.performance_metric	4	?

Figure 4-18 Expert Configuration - Tag Screen



## Expert Configuration - Version



**Advanced Functions**

- Firmware Management
- Import/Export Configuration
- Command Line
- Expert Configuration
- User Application Management
- Change Operating Mode
- Restart

Use **Expert Configuration - Version** to view the version of hardware and software within the reader. The version numbers are read-only. Supply the version number to Motorola Technical Support should they be contacted.

Name	Value	?
version.ext_mux	unknown	?
version.hw	A	?
version.hw_detail	0x0000	?
version.llrp	288	?
version.rmserver	unknown	?
version.rollback	0.6.17013	?
version.sw	0.7.17247	?
version.sw_detail	sw = 0.7.17247, fw = 17246, dsp = 5.0, fpga = 0x000A	?

**Figure 4-19** Expert Configuration - Version Screen

## Expert Configuration - Information

**Expert Configuration - Information** can be used to customize the reader's identity. Use this option to assign each reader a name, description, and location.

The time setting field indicated by **info.time** can not be populated using Expert Configuration. To set the time, use the Command Line to directly enter the time setting command from a web browser. Enter the time command as follows:

Using a web browser, enter the time command (see [Command Line on page 4-16](#))

```
>>> info.time=Year(yyyy)-month(xx)-day(xx)Thour(xx):minutes(xx):seconds(xx).milliseconds(xxx)
```

For example, to set the date to July 26, 2011 and time to 10:50am, 58 seconds and 345 milliseconds, the following command would be entered in the command field:

```
>>> info.time=2011-07-26T10:50:58.345
```

Name	Value	?
info.description	unknown	?
info.location	unknown	?
info.make	FX	?
info.manufacturer	Motorola	?
info.manufacturer_description	Motorola Inc.	?
info.model	9500	?
info.name	unknown	?
info.serial_number	96FF8402038C9FD2	?
info.sub_model	8	?
info.support_contact	unknown	?
info.time	2011-07-29T15:42:51.788	?
info.time_reporting	local ▼	?
info.time_zone	GMT	?
info.unit_number	1114600504904	?
info.zone	unknown	?

**Figure 4-20** Expert Configuration - Information Screen

## Expert Configuration - Communication



**Advanced Functions**

- Firmware Management
- Import/Export Configuration
- Command Line
- Expert Configuration
- User Application Management
- Change Operating Mode
- Restart

**Expert Configuration - Communication** is used to customize the reader's communication parameters.

See [Setup Ethernet/LAN on page 4-7](#) and [Setup Serial Port on page 4-9](#) for additional information.

The following figure shows a portion of communication parameters available on the reader.

Name	Value	?
com.event.overflow_backoff_time	3	?
com.llrp.client_ip_address		?
com.llrp.keepalive_count	3	?
com.llrp.log_level	error	?
com.llrp.reader_init_conn	false	?
com.network.dns_servers	10.1.1.2 10.1.1.18	?
com.network.domain_list	sirt.com	?
com.network.domainname	sirt.com	?
com.network.hostname	sirt_110	?
com.network.ntp_servers	10.2.0.1	?
com.network.tcpkeepalive	true	?
com.network.tcpsynretries	5	?
com.network.1.default_gateway	10.1.1.1	?
com.network.1.ip_address	10.1.1.64	?
com.network.1.ipv6_address	fe80::217:9eff:fe00:152/64	?
com.network.1.ipv6_default_gateway	none	?
com.network.1.ipv6_method	radv_only	?
com.network.1.mac_address	00:17:9E:00:01:52	?
com.network.1.method	dhcp	?
com.network.1.settings	method=dhcp, ipv6_method=radv_only	?
com.network.1.subnet_mask	255.255.255.0	?
com.network.discovery.autonomous	true	?
com.network.discovery.ipv6_request_address	ff04::efc0:0164	?

**Figure 4-21** Expert Configuration - Communication

## Expert Configuration - Antennas

### Advanced Functions

- Firmware Management
- Import/Export Configuration
- Command Line
- Expert Configuration
- User Application Management
- Change Operating Mode
- Restart

Use **Expert Configuration - Antennas** to configure the properties of the reader's antenna configuration

Enter the appropriate values for each antenna parameter and press the **Submit** button to update the antenna and cable configuration.

The following figure shows only a small sample of the available antenna configuration variables.

Name	Value	?
antennas.detected	<input type="text" value="1 2 3 4"/>	?
antennas.mux_sequence	<input type="text" value="1"/>	?
antennas.port_count	<input type="text" value="4"/>	?
antennas.1.conducted_power	<input type="text" value="212"/>	?
antennas.1.advanced.attenuation	<input type="text" value="0"/>	?
antennas.1.advanced.cable_loss	<input type="text" value="10"/>	?
antennas.1.advanced.computed_conducted_power	<input type="text" value="0"/>	?
antennas.1.advanced.gain	<input type="text" value="60"/>	?
antennas.1.advanced.gain_units	<input type="text" value="dbdc"/>	?
antennas.check.time	<input type="text" value="0"/>	?
antennas.check.type	<input type="text"/>	?
antennas.lbt.listen_port	<input type="text"/>	?
antennas.lbt.advanced.cable_loss	<input type="text" value="10"/>	?
antennas.lbt.advanced.gain	<input type="text" value="60"/>	?
antennas.lbt.advanced.gain_units	<input type="text" value="dbdc"/>	?

**Figure 4-22** Expert Configuration - Antenna Screen

## Expert Configuration - Digital I/O



**Advanced Functions**

- Firmware Management
- Import/Export Configuration
- Command Line
- Expert Configuration
- User Application Management
- Change Operating Mode
- Restart

Use the **Expert Configuration - Digital I/O** option to configure the digital inputs and output behavior. Set the digital input debounce time (in milliseconds), as well as the input and output pin values.

Name	Value	?
antennas.detected	<input type="text" value="1 2 3 4"/>	?
antennas.mux_sequence	<input type="text" value="1"/>	?
antennas.port_count	<input type="text" value="4"/>	?
antennas.1.conducted_power	<input type="text" value="212"/>	?
antennas.1.advanced.attenuation	<input type="text" value="0"/>	?
antennas.1.advanced.cable_loss	<input type="text" value="10"/>	?
antennas.1.advanced.computed_conducted_power	<input type="text" value="0"/>	?
antennas.1.advanced.gain	<input type="text" value="60"/>	?
antennas.1.advanced.gain_units	<input type="text" value="dbdc"/>	?
antennas.check.time	<input type="text" value="0"/>	?
antennas.check.type	<input type="text"/>	?
antennas.lbt.listen_port	<input type="text"/>	?
antennas.lbt.advanced.cable_loss	<input type="text" value="10"/>	?
antennas.lbt.advanced.gain	<input type="text" value="60"/>	?
antennas.lbt.advanced.gain_units	<input type="text" value="dbdc"/>	?

**Figure 4-23** Expert Configuration - Digital I/O Screen

## Expert Configuration - Modem



### Advanced Functions

- Firmware Management
- Import/Export Configuration
- Command Line
- Expert Configuration
- User Application Management
- Change Operating Mode
- Restart

Use the **Expert Configuration - Modem** option to set the reader's modem control variables. These variables control functions such as EPC link, modulation depth, return link frequency, and others. The following figure shows only a small sample of the available modem configuration variables.

Name	Value	?
modem.debug.db0	0	?
modem.debug.db1	0	?
modem.debug.db2	0	?
modem.debug.db9	0	?
modem.diag.current_temperature	39	?
modem.diag.error_handler.period	60	?
modem.protocol.cmd_retries	3	?
modem.protocol.easalarm.control.tx_atten	0	?
modem.protocol.isob.control.auto_quiet	false	?
modem.protocol.isob.control.cmd_retries	3	?
modem.protocol.isob.filter.1.address	0	?
modem.protocol.isob.filter.1.data	00	?
modem.protocol.isob.filter.1.enabled	false	?
modem.protocol.isob.filter.1.mask	0	?
modem.protocol.isob.filter.1.opcode	select_eq_flags	?
modem.protocol.isoc.filtering.enabled	false	?
modem.protocol.isoc.filtering.truncated_epc_response	false	?
modem.protocol.isoc.filtering.truncated_tag_epc_length	0	?
modem.protocol.isoc.filtering.use_session	false	?
modem.protocol.isoc.nxp.easalarm_on_collision	false	?
modem.protocol.isoc.physical.data_1_length	d1_len_20	?

Figure 4-24 Expert Configuration - Modem Screen

## User Application Management

**Advanced Functions:**

- Firmware Management
- Import/Export Configuration
- Command Line
- Expert Configuration
- User Application Management
- Change Operating Mode
- Restart

The **User Application Management** option lists user applications currently available, user applications currently running, and allows the user to upload applications on the reader.

### Running User Applications

There are no user applications running on the reader.

### Application Transfer

Application to Transfer:

### Applications available on the reader

Application Name	View	Delete
display_rs232.py	<input type="button" value="View"/>	<input type="button" value="Delete"/>

### Start Applications

Type	Name	Options	Autostart	Submit
Python Applications	display_rs232.py	Arguments: <input type="text"/>	False	<input type="button" value="Go"/>
Java Applications	rapid22.jar	Arguments: <input type="text"/> Class Path: <input type="text"/> Jar: <input type="text"/>	False	<input type="button" value="Go"/>

**Figure 4-25** User Application Management Screen

- **Running User Applications** - Lists user applications currently running on the reader. The application name, process ID, configuration, and status are provided. Controls are provided to view the application file and stop the application.
- **Application Transfer** - Allows the loading of custom user applications onto the reader.
- **Applications available on the reader** - Lists all user applications stored on the reader. Controls are provided to view the application and delete it from the reader.
- **Start Applications** - This function allows for starting Python and Java applications.

✓ **NOTE** Customer applications are not supported by Motorola.

## Change Operating Mode



Use **Change Operating Mode** to configure the operational mode of the reader.

Select	Operating Mode	?
<input type="radio"/>	Active Mode	?
<input checked="" type="radio"/>	Stand By Mode	?

**Figure 4-26** *Operating Mode Screen*

The reader supports the following operational modes:

- **Active Mode** - Reader is continuously attempting to singulate tags and automatically reports any singulated tag via an asynchronous event notification on the event channel.
- **Stand By Mode** - Reader is not transmitting any energy, unless processing a tag related command. The RF transmitter is enabled at the beginning of the command processing, protocol operations required for the command are performed and then the RF transmitter is turned back off.



## View Tags

**i** System Status

- View Tags
- Check Reader Status
- Review Logs

All tags read by the reader are stored in a database on the reader. Use **View Tags** to view the tags in the database as well as change the current Operating Mode (**Active or Stand By**).

Press **Start** to begin displaying the tag database. This page is automatically refreshed every five seconds. Press **Get Once** to update the database one time (refresh is off). Press **Purge** to purge all tags from the database.

### Reader Operating Mode

The current reader operating mode is displayed as the default item in the pulldown list. To change the operating mode, highlight and select the desired mode from the list.

Select	Operating Mode	?
<input type="radio"/>	Active Mode	?
<input checked="" type="radio"/>	Stand By Mode	?

### Tag Database Display

Click on the 'Start' button to begin a display of the reader tag database and continuously refresh the display for the specified polling period. The 'Stop' button stops updating the display of the reader tag database. The 'Get Once' button can be used to display the reader tag database a single time. The 'Purge' button purges all tags from the reader tag database.

Tag ID	Protocol	Antenna	Repeat Counts	First Read Time	Last Read Time
0x3005FB63AC1F3681EC880468	ISOC	1	53	2009-06-08T15:54:37.117	2009-06-08T15:54:38.722

Polling Period (seconds):

**Figure 4-27** Tag Database Display

## Check Reader Status

To view the reader status, select **Check Reader Status**. This information can be used by Motorola Technical Support to verify reader operation.



Name	Value	Status
?	?	?
in_use_memory	46899200	INFO
filesystem/apps	34%	INFO
filesystem/	60%	INFO
modem_uptime	9674	INFO
reader_uptime	9693	INFO
free_memory	16318464	INFO
cpu_load	3	INFO
filesystem/tmp	1%	INFO
tx_interlock	false	NORMAL
synth_locked	true	NORMAL
ps_fault	true	NORMAL
antenna_status	ok	NORMAL
modem_alive	true	NORMAL
discovery	alive	NORMAL
reader	alive	NORMAL
sshd	alive	NORMAL
ssl_cmd_evt	alive	NORMAL
ntpd	stopped	ABNORMAL
c1.py	alive	NORMAL
console	alive	NORMAL
snmpd	alive	NORMAL

Figure 4-28 RFID Reader Status Screen

## Review Logs



To view the reader logs, select **Review Logs**. These logs can be used by Technical Support to verify reader operation. The reader logs include:

- Reader level Logs - System level reader operation
- System Level Logs - Linux logs
- Firmware Update Log - System level
- Reader Applications Log - User application logs
- Command History Log - Recent commands sent to the reader.

Number	Log Type
1	<a href="#">Reader level Logs</a>
2	<a href="#">Reader level Logs (Previous)</a>
3	<a href="#">System Level Logs</a>
4	<a href="#">Firmware Update Log</a>
5	<a href="#">Reader Applications Log</a>
6	<a href="#">Command History Log</a>

**Figure 4-29** Review RFID Reader Logs



# Chapter 5 Configuring Digital Inputs and Outputs

---

## Introduction

This chapter provides information on how to configure the FX9500 RFID Reader Digital Inputs and Outputs.

---

## Digital Inputs

The digital inputs (DIN1 - DIN4) can be used as general purpose inputs or to trigger the reader for tag reading. Unused or open digital inputs are floating inside the reader.

To activate the input, pull it low (0 Vdc) with an external device or connection to ground that can sink 2.5 mA. No voltage higher than +24 Vdc or lower than 0 Vdc should ever be connected to the input. See [Figure 5-1 on page 5-5](#) for an example of a typical motion sensor installed as a tag read trigger device.

---

## Digital Outputs

The digital outputs (DOUT1 - DOUT4) can be used as general purpose outputs, to indicate tag reading activity, or to indicate the reader is transmitting (RF On). Digital outputs can be pulled high.

No voltage higher than +40 Vdc or lower than 0 Vdc should ever be connected to a digital output. The reader activates the output by pulling it low (0 Vdc) and can sink current such that power dissipation  $\leq 1W$ .

---

## Digital I/O Monitoring and Control Scripts

Several digital I/O monitoring and control scripts are provided with the reader to monitor the digital I/Os and take specific actions. These Python application scripts can be used as is or modified to suit your particular application.

**scan\_trigger.py**

This routine monitors the state of the digital input pin specified as the input parameter. If the state of the pin is low, the operating mode is set to *standby*. If the I/O pin state changes to *high*, the operating mode is set to active.

Inputs: <pin> - (optional) Input pin number (1-4). Default is digital in 1.

<trigger logic level> -(optional) 0 or 1. Default is trigger on 1.

Examples:

<code>scan_trigger.py</code>	Monitors digital input pin 1
<code>scan_trigger.py 1</code>	Monitors digital input pin 1
<code>scan_trigger.py 4</code>	Monitors digital input pin 4
<code>scan_trigger.py 3 0</code>	Monitors digital input pin 3, trigger on 0

**scan\_trigger\_timer.py**

This routine monitors the I/O pin. When the pin goes high, the timer is started and the operating mode is set to active. While the timer is running, I/O pin state changes are ignored. When the timer expires, the operating mode is set to standby. The minimum value for the timer is 10 milliseconds (ms).

Inputs: <pin> - (optional) Output pin number (1-4). Default is output 1.

<time> - (optional) Time, in ms for timer to run. Default is 1000 ms.

<trigger logic level> -(optional) 0 or 1. Default is trigger on 1.

Examples:

<code>scan_trigger_timer.py</code>	Monitors input 1, timer 1000 ms, trigger on 1
<code>scan_trigger_timer.py 2</code>	Monitors input 2, timer 1000 ms, trigger on 1
<code>scan_trigger_timer.py 4 2000</code>	Monitors input 4, timer 2000 ms, trigger on 1
<code>scan_trigger_timer.py 3 4000 0</code>	Monitors digital input 3, timer 4000 ms, trigger on 0

## signal\_read.py

This routine will turn on a digital output if a tag is successfully read. The optional output pin number can be specified on the command line. If not specified, output pin 1 is used. The output pin will remain high for n ms, where n is either the default of 1000 ms, or the value supplied on the command line. Minimum value for n is 10 ms.

Inputs:            <pin> - (optional) Output pin number (1-4). Default is output 1.  
                     <time> - (optional) Time, in ms, to keep the output high. Default is 1000 ms (1 sec).  
                     <logic level> - (optional) Logic level for digital out On. 0 or 1. Default is 1 (On).

Examples:

```
signal_read.py           Turns on output 1 for 1000 ms on tag reads
signal_read.py 2        Turns on output 2 for 1000 ms on tag reads
signal_read.py 1 5000   Turns on output 1 for 5000 ms on tag reads
signal_read.py 1 500    Turns on output 1 for 500 ms on tag reads
signal_read.py 1 800 0  Turns on digital output 1, logic level 0, for
                        800 s on tag reads
```

## signal\_read\_crc\_error.py

This routine will turn on a digital output if a tag read CRC error is detected. The output pin number can be specified on the command line. If not specified, output pin 1 is used. The output pin will remain high for n ms, where n is either the default of 1000 ms or the value supplied on the command line. Minimum value for n is 10 ms.

Inputs:            <pin> - (optional) Output pin number (1-4). Default is output 1.  
                     <time> - (optional) Time, in ms, to keep the output high. Default is 1000 ms.  
                     <logic level> - (optional) Logic level for digital out On. 0 or 1. Default is 1 (On).

Examples:

```
signal_read_crc_error.py Turns on output 1 (logic level 1=on), for 1000 ms on tag read CRC error.
signal_read_crc_error.py 2 Turns on output 2 (logic level 1=on), for 1000 ms on tag read CRC error.
signal_read_crc_error.py 1 5000 Turns on output 1 (logic level 1=on), for 5000 ms on tag read CRC error.
signal_read_crc_error.py 1 500 Turns on output 1 (logic level 1=on) for 500 ms on tag read CRC error.
signal_read_crc_error.py 1 800 0 Turns on output 1 (logic level 0=on), for 800 ms on tag CRC error.
```

## rf\_mon.py

This routine will monitor the state of the transmitter. If the transmitter is on, it sets the appropriate output pin high. If low, it sets the output pin low.

Inputs:      <pin> - (optional) Output pin number (1-4). Default is output 1.  
               <logic level> - (optional) Logic level for digital out On. 0 or 1. Default is 1 (On).

Examples:

```
rf_mon.py          Monitors RF status, set/clear output 1 on change, logic level 0 for on
rf_mon.py 1       Monitors RF status, set/clear output 1 on change, logic level 0 for on
rf_mon.py 2       Monitors RF status, set/clear output 2 on change, logic level 0 for on
rf_mon.py 3 0     Monitors RF status, set/clear output 3 on change, logic level 1 for on
```

---

## Digital Input Alarm Generation

The FX9500 can be configured to generate an alarm when a digital input is disconnected or sensor failure is detected. The alarm is triggered when the signal level on the digital input stays in the specified state longer than the specified alarm timeout. This behavior can be configured independently for each digital input.

The configuration variable `dio.in.alarm.logic_level.<N>` (where <N> is 1,2,3,4) sets whether the alarm is coupled to a input logic level of 0 (low) or 1 (high).

The configuration variable `dio.in.alarm.timeout.<N>` (where <N> is 1,2,3,4) sets the amount of time, in seconds, to wait for a signal state change. A value of 0 (default) disables alarm generation.

The digital input logic level is used along with the corresponding digital input pin timeout value to determine if an alarm (in the form of an event) should be generated. If a timeout value is set, the input pin is monitored. If the input pin value does not change during the timeout period AND the input pin value matches the alarm logic level, the event `event.dio.in.alarm.timeout.n` (where n is the pin number) is generated. This alarm event generation can be helpful in alerting to the loss of digital inputs to the reader.







# Appendix A Technical Specifications

---

## Introduction

This chapter provides detailed mechanical, electrical and environmental information for the FX9500 RFID Reader.

## Reader Specifications

**Table A-1** Reader Specifications

Feature	Description
Frequency	902 - 928 MHz (Maximum- some countries truncate this band)
EU Band	865 - 868 MHz
RF Power	10 mW - 1W conducted (Antenna Input - 30 dBm maximum; Reader - 31 dBm)
Power Consumption	10W (typical while idle) 18W (typical at 1W conducted output power) 20W (maximum at 1W conducted output power)
Connections	RS-232, Digital I/O, Ethernet LAN
Input Voltage	24 Vdc, 60W
Input Current	2.5A maximum at 24 Vdc

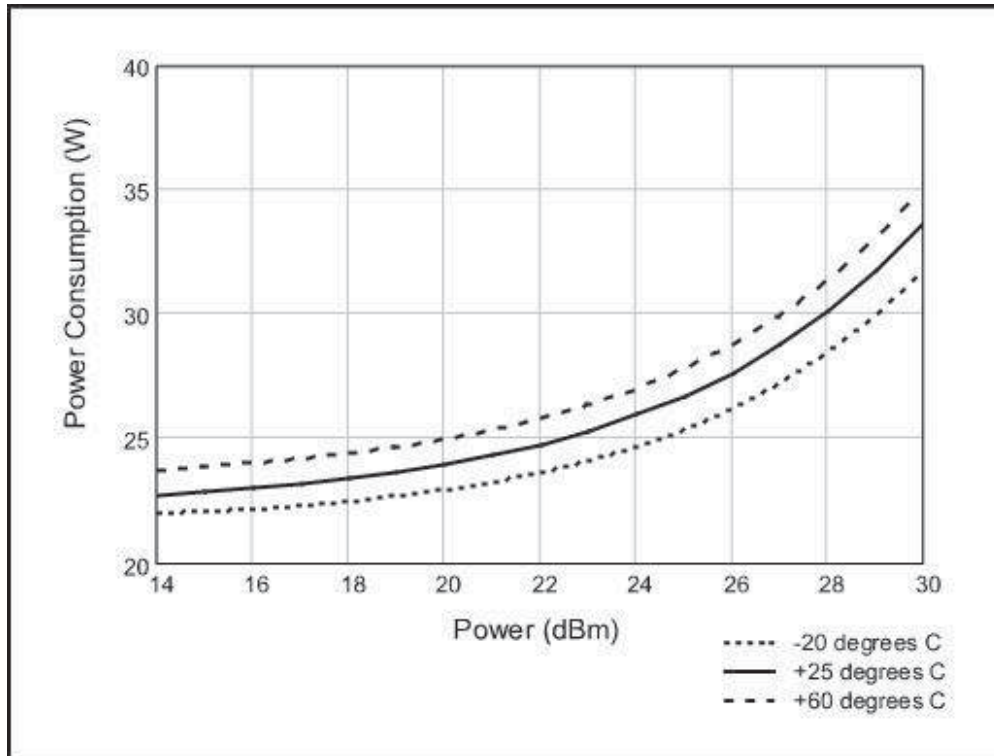

**Figure A-1** Typical Power Consumption versus Conducted Output Power at 910 MHz

---

## Environmental Specifications

**Table A-2** *Environmental Specifications*

Feature	Description
Operating Temperature	4° F to 131° F (-20° C to 55° C)
Storage Temperature	40° F to 185° F (-40° C to 85° C)
Maximum Shock	1 foot (0.3 meter) drop to any corner
Relative Humidity	5% to 95% non-condensing
Case Material	Aluminum
Case Dimensions	9.72 x 7.25 x 2.2 in (246.7 x 184.2 x 55.6 mm)
Weight	4.5 lbs (2.1 kg)

---

## Power Supply Specifications

**Table A-3** *Power Supply Specifications*

Feature	Description
Input Voltage	100 - 240 Vac
Input Consumption	60W maximum
Input Frequency	50 - 60 Hz
Output Voltage	24 VDC
Output Current	4A maximum

## RS-232 Specifications

**Table A-4** RS-232 Specifications

Feature	Description
Connector	DB-9S
Baud rate	1200 - 115200 (Default = 115200)
Parity	None
Data bits	8
Stop bits	1
Signals	Pin 1 - NC Pin 2 - TXD Pin 3 - RXD Pin 4 - DTR (Connected to Pin 6-DSR) Pin 5 - GND Pin 6 - DSR (Connected to Pin 4-DTR) Pin 7 - CTS Pin 8 - RTSA Pin 9 - NC

## Digital Input/Output Specifications

**Table A-5** Digital Input/Output Specifications

Feature	Description
Connector	Phoenix Contact PN 1881422
Input	5 to 24 Vdc, 1 to 5 mA, Optically Isolated
Output	Open Collector (3 to 40 V, 100 mA Max)
Signals	Pin 2 - DIN1 (Digital Input 1) Pin 3 - DIN2 (Digital Input 2) Pin 5 - DIN3 (Digital Input 3) Pin 6 - DIN4 (Digital Input 4) Pin 1, 4 - Digital input common Pin 8 - DOUT1 (Digital Output 1) Pin 9 - DOUT2 (Digital Output 2) Pin 10 - DOUT3 (Digital Output 3) Pin 11 - DOUT4 (Digital Output 4) Pin 7, 12 - Digital output common



**NOTE** Pin 1 is on the right when facing the end of the reader.

---

## Ethernet LAN Specifications

**Table A-6** *Ethernet LAN Specifications*

Feature	Description
Connector	RJ-45
Ethernet	10/100 BaseT
Indicators	Yellow - Indicates link is operational Green - Indicates network traffic detected
Signals	Pin 1 - TXD+ (Transmit Data +) Pin 2 - TXD - (Transmit Data -) Pin 3 - RXD+ (Receive Data +) Pin 4 - NC Pin 5 - NC Pin 6 - RXD - (Receive Data -) Pin 7 - NC Pin 8 - NC

## FX9500 Antenna Specifications

**Table A-7** *Recommended Antenna Specifications*

Feature	Description
Frequency (FCC)	FCC: 902-928 MHz; EU 865-868 MHz
Gain	FCC: 6 dBiL max; EU 6 dBiL max
VSWR, maximum	1.3:1 or less
Front to back ratio	1 dB or less
Input impedance	50 Ohm (nominal)
Power Handling	10 W

✓ **NOTE** USA: This device has been designed to operate with no more than 1 Watt into the antenna with an antenna gain of no more than 6dBiL (with a minimum cable loss of 1dB).

Canada: Antenna having a higher gain is strictly prohibited per regulations of Industry Canada, unless power into the antenna is decreased to compensate for the increased antenna gain. The required antenna impedance is 50 ohms.

To reduce potential radio interference to other users, the antenna type and its gain should be so chosen that the equivalent isotropically radiated power (EIRP) is not more than that required for successful communication.

The installer of this radio equipment must ensure that the antenna is located or pointed such that it does not emit an RF field in excess of Health Canada limits for the general population; consult Safety Code 6, obtainable from Health Canada's website at [www.hc-sc.gc.ca/rpb](http://www.hc-sc.gc.ca/rpb).

Optional Motorola supplied antennas are for indoor use only.

EU: The maximum Radiated Power (ERP) is limited to 2W.



# Appendix B Safety Instructions

---

## Power Disconnect Device

The plug on the power supply cord is intended to be the power disconnect device. As a result, the power source (socket or outlet) shall be located near the equipment and shall be easily accessible.

---

## RF Safety



**CAUTION** FCC Radiation Exposure Statement. The antennas used for this transmitter must be installed to provide a separation distance of at least 25 cm from all persons and must not be co-located or operating in conjunction with any other antenna or transmitter.

EU Radiation Exposure Statement. The antennas used for this transmitter must be installed to provide a separation distance of at least 25 cm from all persons and must not be co-located or operating in conjunction with any other antenna or transmitter.



**IMPORTANT** Always power down the RFID Reader through the web console before removing an antenna or load from an RF port.

---

## Electrostatic Discharge



**CAUTION** FX9500 RFID Reader antenna ports may be susceptible to damage from static discharge or other high voltage. Use proper Electrostatic Discharge (ESD) precautions to avoid static discharge when handling or making connections to the FX9500 RFID reader antenna or communication ports. Equipment failure can result if the antenna or communication ports are subjected to ESD.

---

## Regulatory Compliance



**CAUTION** The FX9500 RFID Reader is designed to meet the regulatory requirements in those jurisdictions in which it is offered. Changes or modifications not expressly approved by Motorola Solutions Inc. for compliance could void the user's authority to operate the equipment.

---

# Appendix C Disposal of Reader

Prior to disposing of the FX9500 RFID Reader, the battery must be removed. The battery used in the FX9500 RFID Reader is a Lithium / Manganese Dioxide (Li/MnO<sub>2</sub>) type. This battery contains no measurable amounts of mercury, lead, or cadmium.



**CAUTION** The procedure outlined in this appendix requires opening the FX9500 RFID Reader case in order to remove the battery prior to disposal. Opening the case of the FX9500 RFID Reader will void the warranty. In addition, opening the case may adversely affect future performance of the reader.

Never open the case of the FX9500 RFID Reader unless you are going to remove the battery and dispose of the unit.

All disposal operations must be performed within local guidelines and laws. It is the responsibility of the reader owner to ensure all local and regional laws and regulations are followed for proper reader disposal.

To remove the battery, perform the following:

1. Remove the reader from service and disconnect any power, antenna, and communication cables.
2. Place the reader on a static protected surface.
3. Turn the reader so the bottom of the reader is facing up as shown in [Figure C-1](#).

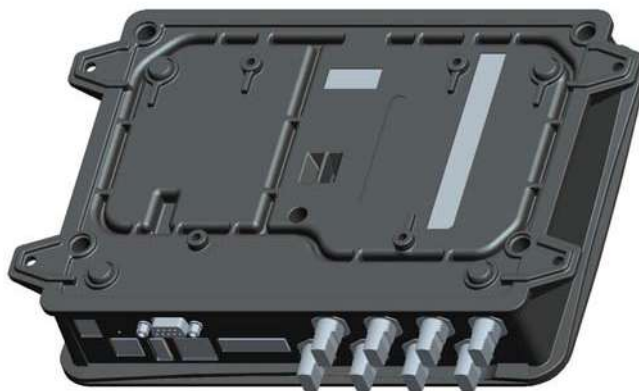

**Figure C-1** *Bottom of Reader*

4. Using a Torx screwdriver, remove the (6) Torx screws securing the reader base to the reader enclosure.

5. Lift the base off the enclosure.
6. Remove the retaining nuts on each antenna connector.
7. Remove the (2) retaining nut/screws on each side of the serial connector.
8. Remove the (6) screws that are securing the board in place.
9. Lift out the main circuit board and turn over.
10. Locate the battery on the upper right quadrant of the board.

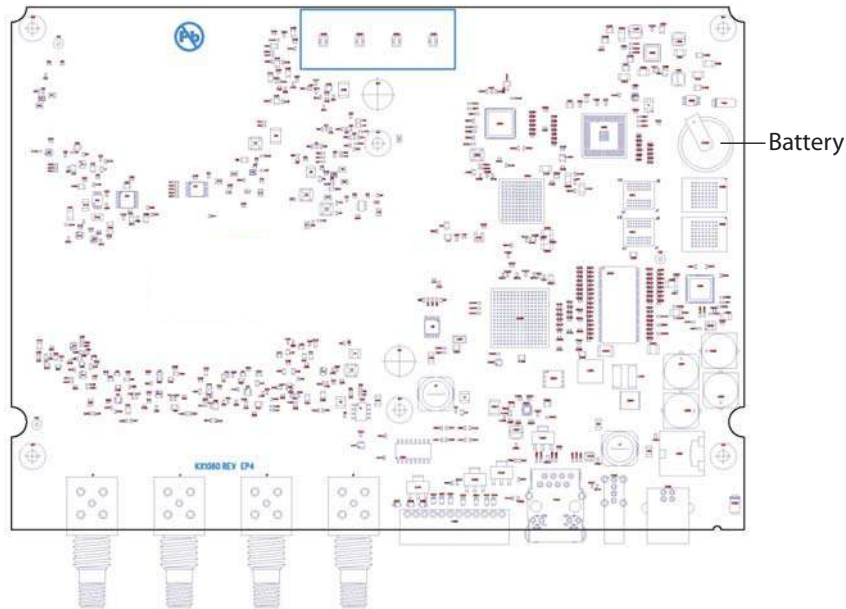

**Figure C-2** *Battery Location*

11. Use a small flat-blade screwdriver to push the battery out of the holder.
12. Properly dispose of battery according to local and regional laws and regulations.
13. Replace the main circuit board and install the base on the reader.
14. Using a Torx (T15) screwdriver, install the (6) torx screws to secure the reader base to the reader enclosure.
15. Properly dispose of reader according to local and regional laws and regulations.

# Index

## A

advanced functions	4-14
antenna mounting	2-3
antenna/cable setup	4-11
attenuation	4-11
cable loss/gain	4-11
conducted power	4-11
mux sequence	4-11

## C

change application mode	
active mode	4-26
stand by mode	4-26
change operating mode	4-26
check reader status	4-28
command line	4-16
command port	4-8
configuration-basic	4-3
configurations	3-ix
connect power	2-7
connect serial port	2-5
connect USB port	2-5
connections	
power and I/O	1-3
control	4-5
control scripts	5-1
conventions	
notational	.xi

## D

demo	
launching	4-2
digital control scripts	5-1
digital I/O hardware connection	5-5

digital I/O monitoring	5-1
digital input	4-10
digital input alarm generation	5-4
digital inputs	5-1
digital output	4-10
digital outputs	5-1
DNS servers	4-8

## E

electrical installation	2-4, 2-5
connect antenna	2-6
connect ethernet port	2-5
connect power	2-7
digital I/O	2-7
ethernet port	2-5
Ethernet/LAN	
general settings	4-6
IPv4/IPv6 settings	4-8
ethernet/LAN setup	4-6
event port	4-8
expert configuration	4-17
antennas	4-22
communication	4-21
digital I/O	4-23
inclusive	4-18
information	4-20
mask	4-18
modem	4-24
name	4-18
pattern	4-18
setup	4-17
tag	4-18
version	4-19
export configuration file	4-15

**F**

file transfer . . . . . 4-15  
 firmware management . . . . . 4-14  
     rollback firmware . . . . . 4-14  
     upgrade firmware . . . . . 4-14

**G**

general settings . . . . . 4-6

**H**

hardware . . . . . 1-2  
     connections . . . . . 1-3  
     status indicator . . . . . 1-3

**I**

I/O connections . . . . . 1-3  
 I/O monitoring . . . . . 5-1  
 image update . . . . . 2-2  
 import licenses . . . . . 4-15  
 import/export Configuration . . . . . 4-15  
     import licenses . . . . . 4-15  
     transfer file . . . . . 4-15  
 import/export configuration  
     export to reader . . . . . 4-15  
     tag . . . . . 4-18  
 IPv4/IPv6 settings . . . . . 4-8

**L**

locating tags . . . . . 5-1  
 login to web console . . . . . 4-3  
 logout of web console . . . . . 4-3

**M**

manage profile  
     activate profile . . . . . 4-5  
     delete a profile . . . . . 4-5  
     enable selected protocols . . . . . 4-5  
     save profile . . . . . 4-4  
 manage profiles . . . . . 4-4  
 mechanical dimensions . . . . . 2-2  
 mechanical installation . . . . . 2-2  
     mechanical dimensions . . . . . 2-2  
     mounting . . . . . 2-2  
 MobileRFID . . . . . 3-x  
 mounting  
     antennas . . . . . 2-3  
     concrete wall mounting . . . . . 2-3  
     drywall mounting . . . . . 2-3

    wood or metal wall mounting . . . . . 2-3  
 mounting reader . . . . . 2-2  
 mux sequence . . . . . 4-11

**N**

NTP servers . . . . . 4-8

**P**

page header configuration . . . . . 4-3  
 password  
     change password . . . . . 3-3  
     default login . . . . . 3-2  
 physical . . . . . 4-5  
 power connections . . . . . 1-3  
 Protocol  
     control . . . . . 4-5  
     physical . . . . . 4-5

**R**

reader  
     specifications . . . . . A-2  
 reader software . . . . . 1-4  
 related documents . . . . . 3-xi  
 related software . . . . . 3-xi  
 review logs . . . . . 4-29

**S**

sample application  
     launching . . . . . 4-2  
 save web console . . . . . 4-4  
 serial port . . . . . 2-5  
 service information . . . . . xii  
 set tag protocol . . . . . 4-5  
 setup digital accessories . . . . . 4-10  
     digital input . . . . . 4-10  
     digital output . . . . . 4-10  
 Setup Ethernet/LAN  
     general settings  
         command port . . . . . 4-8  
         event port . . . . . 4-8  
     IPV\$/IPv6 settings  
         DHCP . . . . . 4-8  
     other settings  
         DNS servers . . . . . 4-8  
         NTP servers . . . . . 4-8  
 setup serial port . . . . . 4-9  
 setup/ethernet LAN  
     other settings . . . . . 4-8  
 software  
     web console . . . . . 1-4

status indicators . . . . . 1-3  
support . . . . . xii

## T

tagged data . . . . . 3-2  
tags  
    locating . . . . . 5-1

## U

updating device . . . . . 2-2  
USB port . . . . . 2-5  
user application management . . . . . 4-25  
    application transfer . . . . . 4-25  
    available applications . . . . . 4-25  
    running user applications . . . . . 4-25  
    start applications . . . . . 4-25

## V

view tags . . . . . 4-27

## W

warranty . . . . . 1-ii  
web console . . . . . 1-4, 3-1, 4-2  
    basic configuration . . . . . 4-3  
    configure page header . . . . . 4-3  
    interface . . . . . 3-1  
    login . . . . . 4-3  
    logout . . . . . 4-3  
    manage profiles . . . . . 4-4  
    profile . . . . . 4-4  
    reader operation . . . . . 3-1  
    save . . . . . 4-4  
    view tagged data . . . . . 3-2









**MOTOROLA**

Motorola Solutions, Inc.  
One Motorola Plaza  
Holtsville, New York 11742, USA  
1-800-927-9626  
<http://www.motorolasolutions.com>

MOTOROLA, MOTO, MOTOROLA SOLUTIONS and the Stylized M Logo are trademarks or registered trademarks of Motorola Trademark Holdings, LLC and are used under license. All other trademarks are the property of their respective owners.  
© 2011 Motorola Solutions, Inc. All rights reserved.



72E-150900-03 Revision A - January 2012